

V2 | SEPT 2021



MANHATTAN

100W BLUETOOTH SPEAKER



USER MANUAL

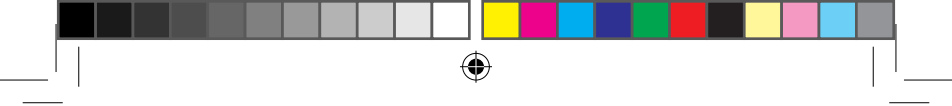



Content

English	5
German	15
French	25
Dutch	35
Spanish	45
Italian	55



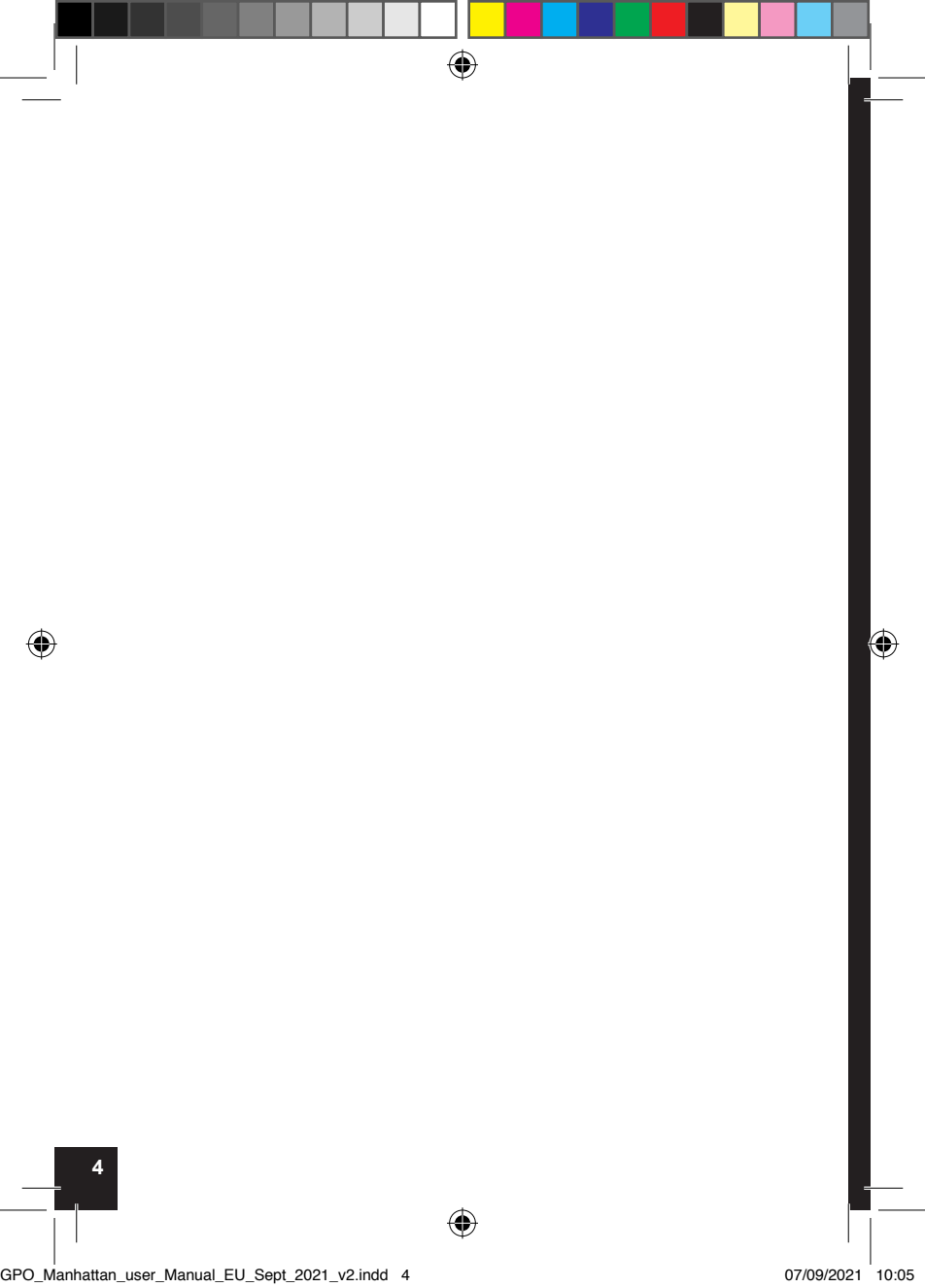



English



Introduction

Thanks for purchasing the GPO Manhattan Speaker. This compact portable speaker allows you to listen to music via Bluetooth, USB or using the AUX input.

Includes:

- 1x GPO Manhattan Speaker
- 1x Power Cable
- 1x 3.5mm AUX Cable

Before using your GPO Manhattan Speaker for the first time, make sure that you read these instructions and keep them safe for future reference.



Control Locations



- | | |
|--------------------------|------------------------|
| 1. LED Display | 12. USB Slot |
| 2. Volume Knob | 13. AUX IN Jacks |
| 3. Balance Knob | 14. Mic1 and Mic2 fade |
| 4. Bass Knob | 15. Echo |
| 5. Treble Knob | 16. Speakers |
| 6. Power Button | 17. Handle |
| 7. Lights | 18. Power Jack (REAR) |
| 8. Mode Selection Button | 19. Play/Pause |
| 9. Pair | 20. Skip/Back |
| 10. Rec | 21. Skip/Next |
| 11. Microphone Jacks | |

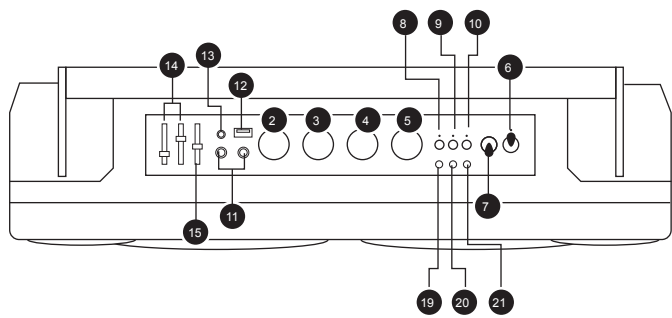
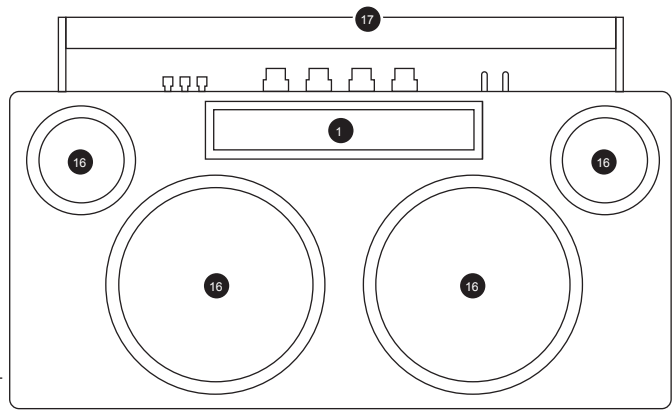



Operating the GPO Manhattan

Use the power switch to turn your GPO Manhattan on or off.
When turned on, the power button's LED indicator will light up.

Sound Control

Adjust the GPO Manhattan's volume, balance, bass and treble using the knobs on top of the unit.

LED Display



Use the LED switch on top of the unit to turn your GPO Manhattan's LED display on or off.

When turned on, the power button's LED indicator will light up and the display on the front of the unit will be visible.



Tap the Pair button to cycle through six preset display modes. If no music is playing, the LED display will display a sample of the preset display mode, regardless of the display selection.

Playback Modes

The GPO Manhattan has three modes: Bluetooth, AUX and USB.



Bluetooth Mode

Bluetooth Mode is selected in two ways:

1. When the GPO Manhattan is switched on, Bluetooth Mode is selected by default and the unit looks to pair with a nearby device.
2. From AUX Mode, tap the Mode Selection button once.

The Mode Selection LED turns blue.

Hold down the Pair button to turn on the pairing function. The Pairing LED will quickly flash to let you know that the GPO Manhattan is in pairing mode.

Use your smartphone or other Bluetooth-enabled device's Bluetooth pairing function to identify and connect with the GPO Manhattan unit. Playback can then be managed from your device directly or the GPO Manhattan.



Broadcast Mode



This is a function unique to the GPO Manhattan. It allows multiple units to be linked together and controlled as a single entity.

Hold down the Mode Selection button to turn on Broadcast Mode. The equalizer will show "H", indicating that this is the Broadcasting Host Unit.

For each additional GPO Manhattan, turn the unit on and hold down the Mode Selection button to enter Broadcast Mode then hold down the Mode Selection button again to designate the unit as a Broadcasting Support Unit. The equalizer will show "S".

To remove the unit from the Broadcasting group, hold the Mode Selection button once more. The equalizer will show "N", indicating that the unit is not connected to any other GPO Manhattan unit.

Once you are happy with the group, use the following buttons to control audio playback:



Tap the Play/Pause button to play or pause the current song.

Tap the Skip/Next button to skip forward to the next song on the connected device.

Hold the Skip/Next button to unpair the current device and re-enter pairing as described above.

Tap the Skip/Back button to skip back to the previous song on the connected device.

Holding the Skip/Back button has no effect.

AUX Mode

From Bluetooth Mode, tap the Mode Selection button once to select AUX Mode. The mode selection LED indicator turns red.

To play music from a separate device, connect the GPO Manhattan using an AUX cable. Playback must be managed from the connected device.

Tapping the Play/Pause button while in AUX mode will have no effect.

Tapping or holding the Skip/Next button in AUX mode will have no effect.

Tapping or holding the Skip/Back button in AUX mode will have no effect.



USB Mode

From AUX Mode, tap the Mode Selection button once more to select USB Mode. The Mode Selection LED turns purple.

To play music saved on a USB device in mp3 format, insert the USB device into the USB port on your GPO Manhattan. Playback can then be managed from the GPO Manhattan.

Tap the Play/Pause button to play or pause the current song.

Tap the Skip/Next button to skip forward to the next song on the USB storage.

Hold the Skip/Next button to fast forward through the current song until the button is released.

Tap the Skip/Back button to skip back to the previous song on the USB storage.



Hold the Skip/Back button to rewind back through the current song until the button is released.





Using Microphones – All Modes

Hold down the Play/Pause button to turn on the MIC sound effects.

Tap the Play/Pause this button to cycle through the seven types of sound effect:

- Diacritic
- Magic
- Shouting
- Goddess
- Male
- Baby Voice
- Pop Reverb



Recording to a USB device

During playback in Bluetooth or AUX Mode, insert the USB device you would like to record to.

Tap the record button to start recording. The indicator will turn on.

Tap the record button again to stop recording. The indicator will turn off.

If the indicator will not turn on, ensure that there is enough memory on the USB device.

Charging the GPO Manhattan

Your GPO Manhattan can play music for up to four hours in Bluetooth mode, depending on the volume setting. It takes around two hours to fully recharge.

To charge the GPO Manhattan, insert the charging cable and connect the unit to an electrical supply.

While charging, the blue charging light will flash.

Once the unit is fully charged, the charging light will continuously shine blue.

When the unit's battery is low, the red power light will flash slowly.



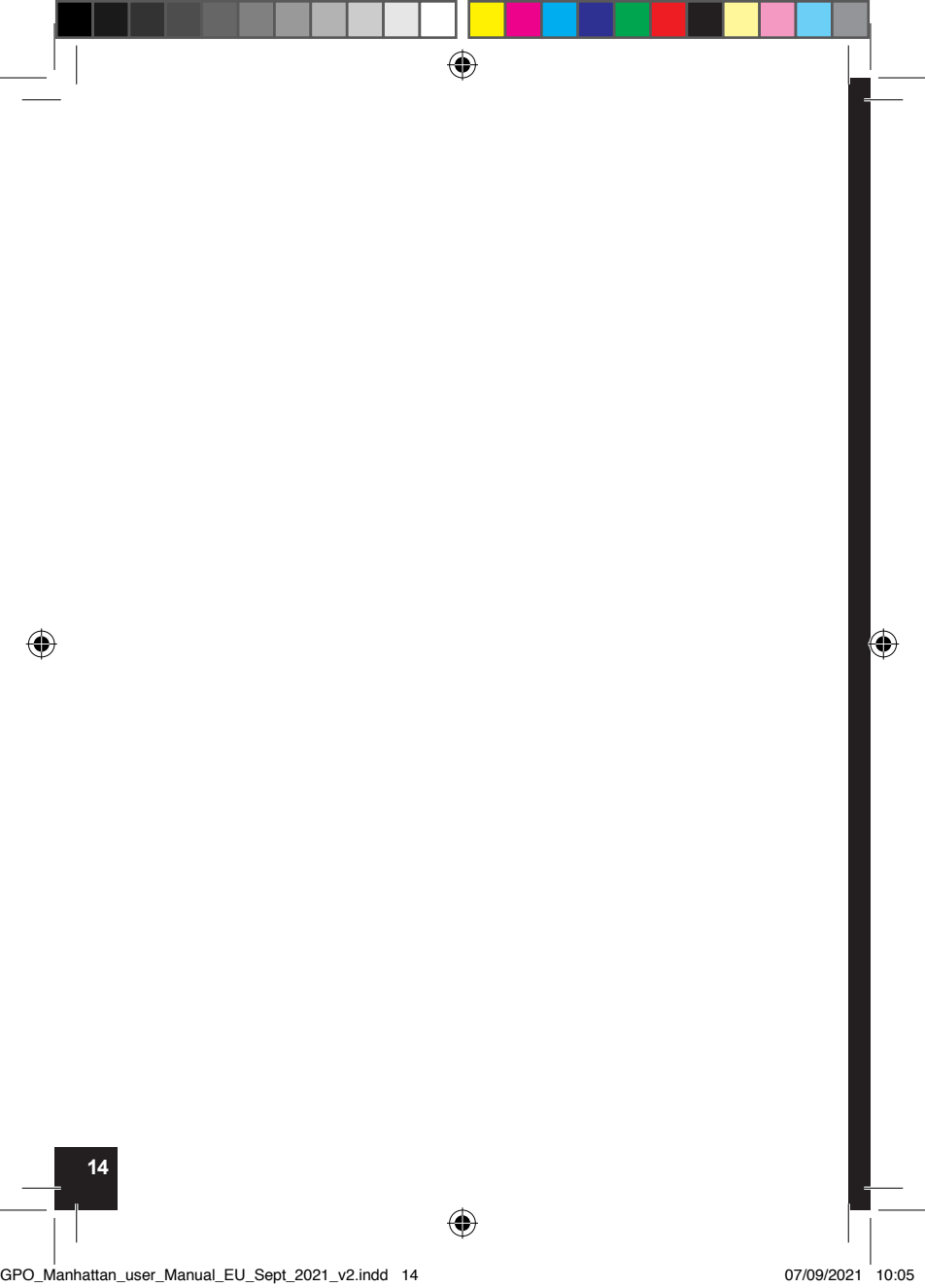



German

Einführung

Vielen Dank für den Kauf des GPO Manhattan Lautsprechers. Mit diesem kompakten tragbaren Lautsprecher können Sie Musik über Bluetooth, USB oder über den AUX-Eingang hören.

Es umfasst:

- 1x GPO Manhattan Lautsprecher
- 1x Netzkabel
- 1x AUX-Kabel

Bevor Sie Ihren GPO Manhattan Lautsprecher zum ersten Mal in Betrieb nehmen, sollten Sie diese Anleitung unbedingt lesen und zum späteren Nachschlagen aufbewahren.

Kontrollorte

- | | |
|---------------------------------------|------------------------------|
| 1. LED-Anzeige | 11. Mikrofonbuchsen |
| 2. Lautstärketaste | 12. USB-Anschluss |
| 3. Balance-Taste | 13. Hilfsenergie-Buchsen |
| 4. Taste zur Regelung des tiefen Tons | 14. Mic1 und Mic2 aus |
| 5. Taste zur Regelung des hohen Tons | 15. Echo |
| 6. Netzschalter | 16. Lautsprecher |
| 7. Lichter | 17. Handgriff |
| 8. Modusauswahl Taste | 18. Steckdose (HINTEREN) |
| 9. Paarung | 19. Spielpause |
| 10. Registrieren | 20. Überspringen/zurück |
| | 21. Das Nächste überspringen |

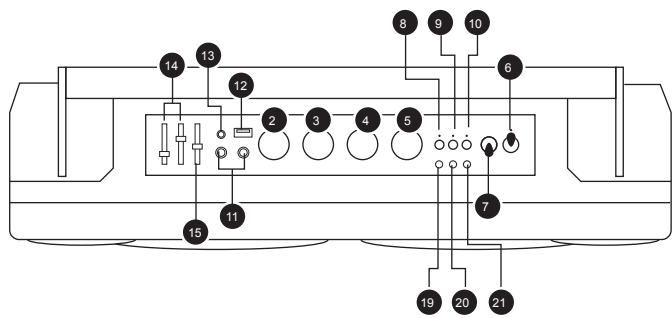
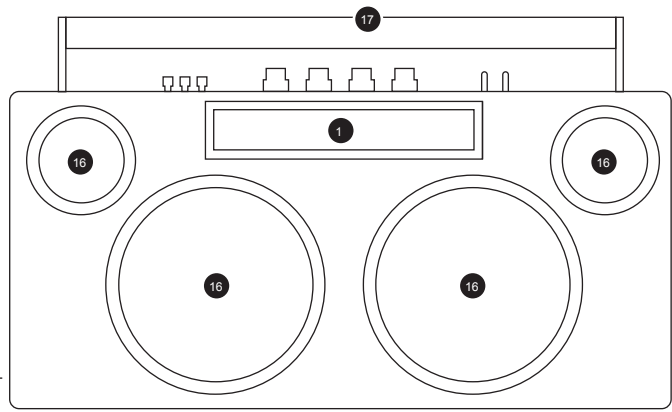



Bedienung des GPO Manhattan

Mit dem Netzschalter schalten Sie Ihren GPO Manhattan ein oder aus. Wenn er eingeschaltet ist, leuchtet die LED-Anzeige des Netzschalters auf.

Tonsteuerung

Stellen Sie Lautstärke, Balance, Bässe und Höhen des GPO Manhattan mit den Reglern auf der Oberseite des Geräts ein.

LED-Anzeige

Verwenden Sie den LED-Schalter auf der Oberseite des Geräts, um die LED-Anzeige Ihres GPO Manhattan ein- oder auszuschalten.

Wenn es eingeschaltet ist, leuchtet die LED-Anzeige des Netzschalters auf und das Display auf der Vorderseite des Geräts ist sichtbar.

Tippen Sie auf die Pair-Taste, um durch sechs voreingestellte Anzeigemodi zu blättern. Wenn keine Musik abgespielt wird, zeigt das LED-Display ein Beispiel des voreingestellten Anzeigemodus an, unabhängig von der Anzeigeauswahl

Bluetooth-Modus

Der Bluetooth-Modus kann auf zwei Arten ausgewählt werden:

1. Wenn der GPO Manhattan eingeschaltet wird, ist der Bluetooth-Modus standardmäßig ausgewählt und das Gerät sucht nach einer Verbindung mit einem Gerät in der Nähe.
2. Tippen Sie im AUX-Modus einmal auf die Taste Mode Selection.



Die LED für die Modusauswahl leuchtet blau.

Halten Sie die Taste Pair gedrückt, um die Pairing-Funktion einzuschalten. Die Pairing-LED blinkt schnell, um Sie darauf hinzuweisen, dass sich der GPO Manhattan im Pairing-Modus befindet.

Verwenden Sie die Bluetooth-Pairing-Funktion Ihres Smartphones oder eines anderen Bluetooth-fähigen Geräts, um den GPO Manhattan zu identifizieren und mit ihm zu verbinden. Die Wiedergabe kann dann direkt von Ihrem Gerät oder dem GPO Manhattan gesteuert werden.

Broadcast-Modus

Dies ist eine Funktion, die nur im GPO Manhattan verfügbar ist. Mit ihr können mehrere Geräte miteinander verbunden und als eine Einheit gesteuert werden.



Halten Sie die Moduswahl Taste gedrückt, um den Broadcast-Modus einzuschalten. Auf dem Equalizer wird "H" angezeigt, was bedeutet, dass dies die Broadcasting Host Unit ist.





Schalten Sie für jeden weiteren GPO Manhattan das Gerät ein und halten Sie die Modus-Wahl Taste gedrückt, um den Broadcast-Modus zu aktivieren, und halten Sie dann die Modus-Wahl Taste erneut gedrückt, um das Gerät als Broadcasting Support Unit zu kennzeichnen. Auf dem Equalizer wird "S" angezeigt.

Um das Gerät aus der Broadcasting-Gruppe zu entfernen, halten Sie die Moduswahl Taste erneut gedrückt. Der Equalizer zeigt nun "N" an, was bedeutet, dass das Gerät mit keinem anderen GPO Manhattan-Gerät verbunden ist.

Wenn Sie mit der Gruppe zufrieden sind, verwenden Sie die folgenden Tasten, um die Audiowiedergabe zu steuern:

Tippen Sie auf die Play/Pause-Taste, um den aktuellen Song abzuspielen oder zu pausieren.



Tippen Sie auf die Skip/Next-Taste, um zum nächsten Song auf dem angeschlossenen Gerät vorzuspringen.

Halten Sie die Taste Skip/Next gedrückt, um die Kopplung des aktuellen Geräts aufzuheben und die Kopplung wie oben beschrieben erneut durchzuführen.

Tippen Sie auf die Taste Skip/Back, um zum vorherigen Song auf dem angeschlossenen Gerät zu springen.

Das Gedrückthalten der Skip/Back-Taste hat keine Wirkung.

AUX-Modus



Tippen Sie im Bluetooth-Modus einmal auf die Modusauswahl Taste, um den AUX-Modus auszuwählen. Die LED-Anzeige für die Modusauswahl leuchtet rot.

Um Musik von einem separaten Gerät abzuspielen, schließen Sie den GPO Manhattan über ein AUX-Kabel an. Die Wiedergabe muss über das angeschlossene Gerät gesteuert werden.

Das Antippen der Play/Pause-Taste im AUX-Modus hat keine Wirkung.

Wenn Sie die Taste Skip/Next im AUX-Modus antippen oder gedrückt halten, hat dies keine Auswirkung.

Das Antippen oder Halten der Taste Skip/Back im AUX-Modus hat keine Auswirkung.





USB-Modus

Tippen Sie im AUX-Modus ein weiteres Mal auf die Modusauswahl-taste, um den USB-Modus auszuwählen. Die Modus-Auswahl-LED leuchtet lila.

Um auf einem USB-Gerät gespeicherte Musik im mp3-Format abzuspielen, stecken Sie das USB-Gerät in den USB-Anschluss Ihres GPO Manhattan. Die Wiedergabe kann dann vom GPO Manhattan aus gesteuert werden.

Tippen Sie auf die Play/Pause-Taste, um den aktuellen Song abzuspielen oder zu pausieren.

Tippen Sie auf die Skip/Next-Taste, um zum nächsten Song auf dem USB-Speicher zu springen.

Halten Sie die Skip/Next-Taste gedrückt, um im aktuellen Song vorzuspringen, bis Sie die Taste loslassen.

Tippen Sie auf die Skip/Back-Taste, um zum vorherigen Song auf dem USB-Speicher zurückzuspringen.

Halten Sie die Skip/Back-Taste gedrückt, um durch den aktuellen Song zurückzuspringen, bis Sie die Taste loslassen.



Verwenden von Mikrofonen - Alle Modi

Halten Sie die Play/Pause-Taste gedrückt, um die MIC-Soundeffekte einzuschalten.

Tippen Sie auf die Play/Pause-Taste, um durch die sieben Arten von Soundeffekten zu schalten:

- Diakritisch
- Magie
- Schreie
- Göttin
- Männlich
- Baby-Stimme
- Pop-Hall



Aufnahme auf ein USB-Gerät

Stecken Sie während der Wiedergabe im Bluetooth- oder AUX-Modus das USB-Gerät ein, auf das Sie aufnehmen möchten.

Tippen Sie auf die Aufnahmetaste, um die Aufnahme zu starten. Die Anzeige schaltet sich ein.

Tippen Sie erneut auf die Aufnahmetaste, um die Aufnahme zu beenden. Die Anzeige schaltet sich aus.

Wenn die Anzeige nicht aufleuchtet, vergewissern Sie sich, dass auf dem USB-Gerät genügend Speicherplatz vorhanden ist.



Aufladen des GPO Manhattan

Ihr GPO Manhattan kann im Bluetooth-Modus bis zu vier Stunden lang Musik abspielen, je nach Lautstärkeinstellung. Es dauert etwa zwei Stunden, bis es wieder vollständig aufgeladen ist.

Um den GPO Manhattan aufzuladen, stecken Sie das Ladekabel ein und schließen Sie das Gerät an eine Steckdose an.

Während des Ladevorgangs blinkt die blaue Ladeanzeige.

Sobald das Gerät vollständig aufgeladen ist, leuchtet die Ladeanzeige kontinuierlich blau.

Wenn der Akku des Geräts schwach ist, blinkt die rote Betriebsleuchte langsam.



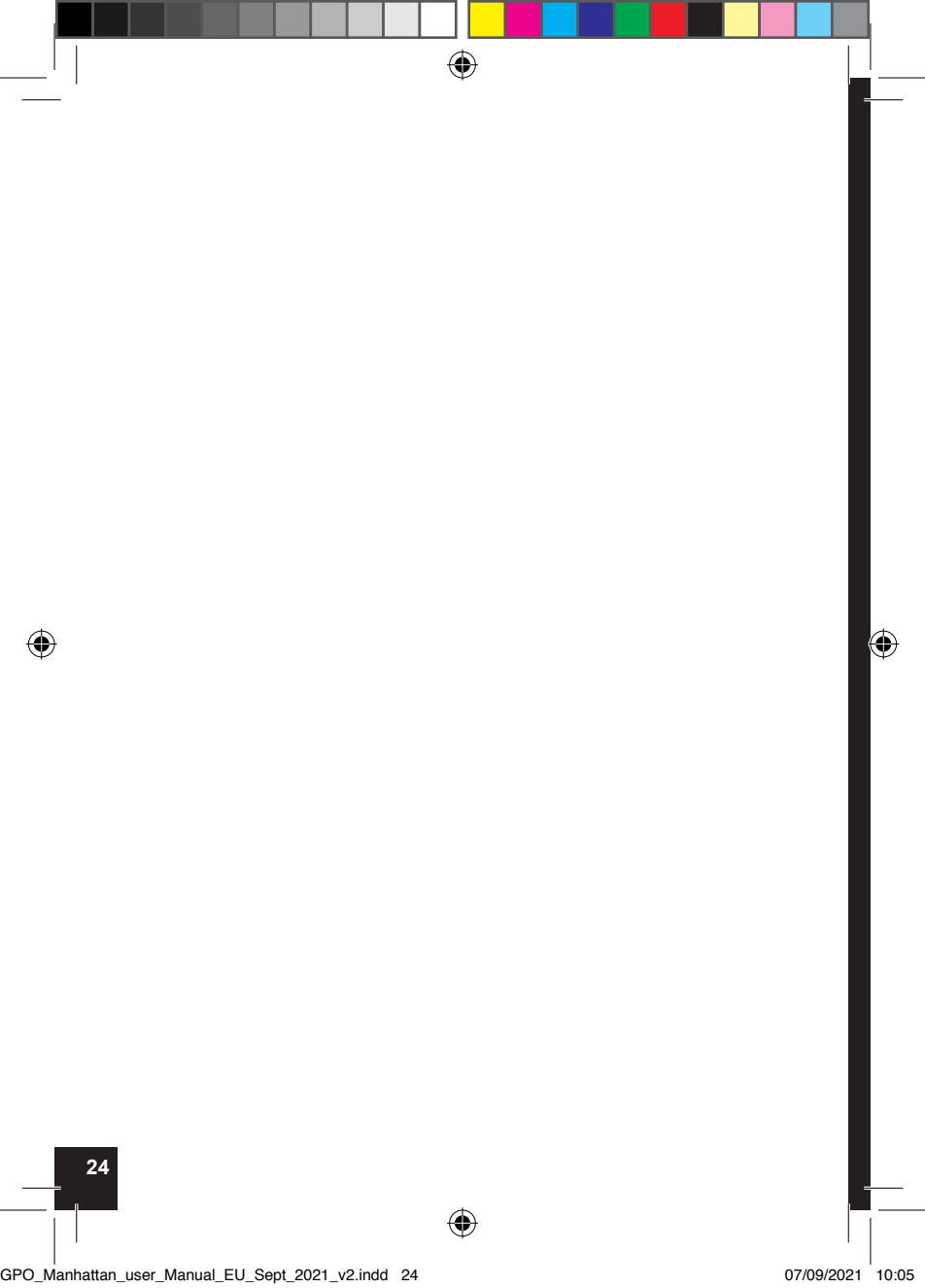



French



Introduction

Merci d'avoir acheté le haut-parleur GPO Manhattan. Ce haut-parleur compact et portable vous permet d'écouter de la musique via Bluetooth, USB ou en utilisant l'entrée AUX.

Il comprend :

- 1x haut-parleur GPO Manhattan
- 1x câble d'alimentation
- 1x câble AUX

Avant d'utiliser votre haut-parleur GPO Manhattan pour la première fois, assurez-vous de lire ces instructions et de les conserver pour toute référence ultérieure.



Emplacements de contrôle



- | | |
|----------------------------------|-----------------------------------------|
| 1. Affichage LED | 13. Prises d'alimentation
auxiliaire |
| 2. Bouton de volume | 14. Mic1 et Mic2 éteints |
| 3. Bouton de balance | 15. Echo |
| 4. Bouton de contrôle des graves | 16. Haut-parleurs |
| 5. Bouton de contrôle des aigus | 17. Poignée |
| 6. Bouton d'alimentation | 18. Prise d'alimentation
(ARRIÈRE) |
| 7. Lumières | 19. Jouer/Pause |
| 8. Bouton de sélection de mode | 20. Sauter/Retour |
| 9. Jumelage | 21. Sauter/Prochaine |
| 10. Enregistrer | |
| 11. Prises de microphone | |
| 12. Port USB | |

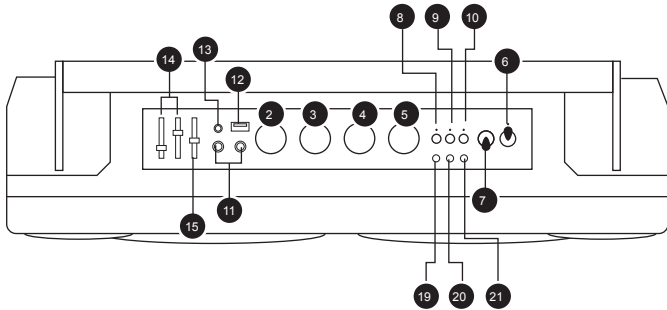
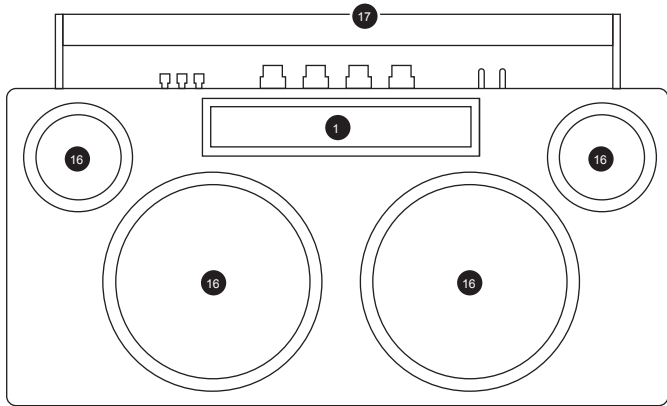



Utilisation du GPO Manhattan

Utilisez le bouton d'alimentation pour allumer ou éteindre votre GPO Manhattan.

Lorsqu'il est allumé, l'indicateur LED du bouton d'alimentation s'allume.

Contrôle sonore

Réglez le volume, la balance, les basses et les aigus du GPO Manhattan à l'aide des boutons situés sur le dessus de l'appareil.

Affichage LED



Utilisez l'interrupteur LED situé sur le dessus de l'unité pour allumer ou éteindre l'affichage LED de votre GPO Manhattan.



Lorsqu'il est allumé, l'indicateur LED du bouton d'alimentation s'allume et l'écran à l'avant de l'appareil est visible.

Appuyez sur le bouton de sélection du mode pour faire défiler les six modes d'affichage prédéfinis. Si aucune musique n'est en cours de lecture, l'affichage LED restera statique, quelle que soit la sélection de l'affichage.

Modes de lecture

Le GPO Manhattan dispose de trois modes : Bluetooth, AUX et USB.

Mode Bluetooth

Le mode Bluetooth peut être sélectionné de deux façons :

1. Lorsque le GPO Manhattan est allumé, le mode Bluetooth est sélectionné par défaut et l'appareil cherche à se jumeler avec un appareil à proximité.
2. Depuis le mode AUX, appuyez une fois sur le bouton de sélection du mode.

La LED de sélection du mode devient bleue.

Maintenez le bouton Pair enfoncé pour activer la fonction d'appairage. La LED de jumelage clignote rapidement pour vous indiquer que le GPO Manhattan est en mode de jumelage.



Utilisez la fonction d'appairage Bluetooth de votre smartphone ou autre appareil compatible Bluetooth pour identifier et vous connecter à l'unité GPO Manhattan. La lecture peut alors être gérée depuis votre appareil directement ou depuis le GPO Manhattan.

Mode de diffusion

Il s'agit d'une fonction propre au GPO Manhattan. Elle permet à plusieurs unités d'être reliées entre elles et contrôlées comme une seule entité.

Maintenez le bouton de sélection du mode enfoncé pour activer le mode de diffusion. L'égaliseur affiche "H", indiquant qu'il s'agit de l'unité hôte de diffusion.

Pour chaque GPO Manhattan supplémentaire, allumez l'unité et maintenez le bouton de sélection du mode enfoncé pour passer en mode de diffusion, puis maintenez à nouveau le bouton de sélection du mode enfoncé pour désigner l'unité comme unité de support de diffusion. L'égaliseur affichera "S".



Pour retirer l'unité du groupe de diffusion, maintenez le bouton de sélection de mode enfoncé une fois de plus. L'égaliseur affiche "N", indiquant que l'appareil n'est connecté à aucun autre appareil du GPO Manhattan.

Une fois que vous êtes satisfait du groupe, utilisez les boutons suivants pour contrôler la lecture audio :

Touchez le bouton Play/Pause pour lire ou mettre en pause le morceau en cours.

Appuyez sur le bouton Skip/Next pour passer à la chanson suivante sur l'appareil connecté.

Maintenez le bouton Skip/Next enfoncé pour annuler le jumelage du périphérique actuel et recommencer le jumelage comme décrit ci-dessus.

Appuyez sur le bouton Skip/Back pour revenir à la chanson précédente sur l'appareil connecté.

Le fait de maintenir le bouton Skip/Back n'a aucun effet.

Mode AUX

En mode Bluetooth, appuyez une fois sur le bouton de sélection du mode pour sélectionner le mode AUX. L'indicateur LED de sélection de mode devient rouge.

Pour écouter de la musique à partir d'un autre appareil, connectez le GPO Manhattan à l'aide d'un câble AUX. La lecture doit être gérée à partir de l'appareil connecté.

Le fait de toucher le bouton Play/Pause en mode AUX n'a aucun effet.

Le fait de toucher ou de maintenir le bouton Skip/Next en mode AUX n'a aucun effet.

Le fait d'appuyer sur le bouton Skip/Back ou de le maintenir enfoncé en mode AUX n'a aucun effet.



Mode USB

En mode AUX, appuyez une fois de plus sur le bouton Sélection du mode pour sélectionner le mode USB. La LED de sélection du mode devient violette.

Pour lire de la musique sauvegardée sur un périphérique USB au format MP3, insérez le périphérique USB dans le port USB de votre GPO Manhattan. La lecture peut alors être gérée depuis le GPO Manhattan.

Appuyez sur le bouton Play/Pause pour lire ou mettre en pause le morceau en cours.

Appuyez sur le bouton Skip/Next pour passer à la chanson suivante sur la clé USB.

Maintenez le bouton Skip/Next pour avancer rapidement dans le morceau en cours jusqu'à ce que vous relâchiez le bouton.

Appuyez sur le bouton Skip/Back pour revenir à la chanson précédente sur la clé USB.

Maintenez le bouton Skip/Back enfoncé pour revenir en arrière dans la chanson en cours jusqu'à ce que vous relâchiez le bouton.



Utilisation des microphones - Tous les modes

Maintenez le bouton Play/Pause enfoncé pour activer les effets sonores MIC.

Appuyez sur le bouton Play/Pause pour faire défiler les sept types d'effets sonores :

- Diacritique
- Magie
- Cris
- Déesse
- Homme
- Voix de bébé
- Réverbération pop



Enregistrement sur un périphérique USB

Pendant la lecture en mode Bluetooth ou AUX, insérez le périphérique USB sur lequel vous souhaitez enregistrer.

Appuyez sur le bouton d'enregistrement pour commencer l'enregistrement. L'indicateur s'allume.

Appuyez à nouveau sur le bouton d'enregistrement pour arrêter l'enregistrement. L'indicateur s'éteint.

Si l'indicateur ne s'allume pas, vérifiez que la mémoire du périphérique USB est suffisante.



Chargement du GPO Manhattan



Votre GPO Manhattan peut diffuser de la musique pendant quatre heures en mode Bluetooth, selon le réglage du volume. Il faut environ deux heures pour le recharger complètement.

Pour charger le GPO Manhattan, insérez le câble de charge et branchez l'appareil sur une prise électrique.

Pendant la charge, le voyant de charge bleu clignote.

Une fois l'appareil complètement chargé, le voyant de charge reste bleu en permanence.

Lorsque la batterie de l'appareil est faible, le voyant d'alimentation rouge clignote lentement.







Dutch

Inleiding

Bedankt voor uw aankoop van de GPO Manhattan luidspreker. Met deze compacte draagbare luidspreker kunt u naar muziek luisteren via Bluetooth, USB of via de AUX-ingang.

Het omvat:

- 1x GPO Manhattan Luidspreker
- 1x Stroomkabel
- 1x AUX-Kabel

Voordat u uw GPO Manhattan luidspreker voor de eerste keer gebruikt, moet u deze instructies lezen en bewaren voor toekomstig gebruik.

Controle locaties

- | | |
|------------------------------|---------------------------|
| 1. LED-scherm | 12. USB-poort |
| 2. Volumeknop | 13. Auxiliary power jacks |
| 3. Balans knop | 14. Mic1 en Mic2 uit |
| 4. Regelknop voor lage tonen | 15. Echo |
| 5. Regelknop voor hoge tonen | 16. Sprekers |
| 6. Aan/uit-knop | 17. Handvat |
| 7. Lichten | 18. Stopcontact (ACHTER) |
| 8. Modusselectieknop | 19. Reproducir / pausar |
| 9. Koppelen | 20. Overslaan/Rug |
| 10. Registreren | 21. Overslaan/Volgende |
| 11. Microfoon aansluitingen | |

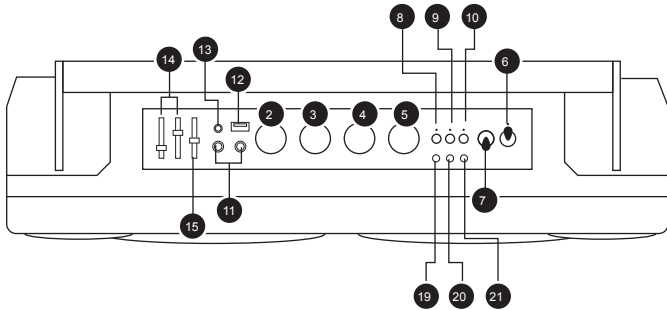
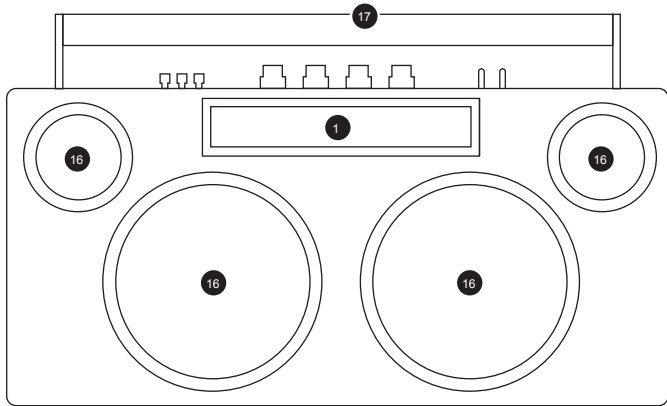



De GPO Manhattan bedienen

Gebruik de aan/uit-schakelaar om uw GPO Manhattan aan of uit te zetten.

Als hij aan staat, gaat de LED-indicator van de aan/uit-knop branden.

Geluidsbeheersing

Regel het volume, de balans, de bas en de hoge tonen van de GPO Manhattan met de knoppen bovenop het toestel.

LED Scherm

Gebruik de LED-schakelaar op de bovenkant van het apparaat om het LED-display van uw GPO Manhattan aan of uit te zetten.

Wanneer ingeschakeld, zal de LED-indicator van de aan/uit-knop oplichten en zal het display op de voorkant van het apparaat zichtbaar zijn.

Tik op de knop Koppelen om door zes vooraf ingestelde weergavemodi te bladeren. Als er geen muziek wordt afgespeeld, geeft het LED-display een voorbeeld van de vooraf ingestelde weergavemodus weer, ongeacht de weergaveselectie.

Afspielmodi

De GPO Manhattan heeft drie modi: Bluetooth, AUX en USB.



Bluetooth-modus

De Bluetooth-modus kan op twee manieren worden geselecteerd:

1. Wanneer de GPO Manhattan wordt ingeschakeld, wordt standaard de Bluetooth-modus geselecteerd en zoekt het toestel naar een koppeling met een apparaat in de buurt.
2. Tik vanuit de AUX-modus eenmaal op de knop Modusselectie.

De modus selectie LED wordt blauw.

Houd de Pair-knop ingedrukt om de koppelingsfunctie in te schakelen. De koppelings-LED knippert snel om u te laten weten dat de GPO Manhattan in de koppelingsmodus staat.

Gebruik de Bluetooth-koppelingsfunctie van uw smartphone of ander Bluetooth-apparaat om het GPO Manhattan-apparaat te identificeren en er verbinding mee te maken. Het afspelen kan vervolgens rechtstreeks vanaf uw apparaat of vanaf de GPO Manhattan worden geregeld.





Uitzendmodus

Dit is een functie die uniek is voor GPO Manhattan. Hiermee kunnen meerdere eenheden aan elkaar worden gekoppeld en als één eenheid worden bestuurd.

Houd de Mode Selectieknop ingedrukt om de Broadcast Mode in te schakelen. De equalizer toont "H", wat aangeeft dat dit de Broadcast Host Unit is.

Voor elke bijkomende GPO Manhattan, zet u het toestel aan en houdt u de Mode Selection toets ingedrukt om de Broadcast Mode in te schakelen, vervolgens houdt u de Mode Selection toets nogmaals ingedrukt om het toestel als Broadcast Support Unit aan te duiden. De equalizer zal "S" tonen.

Om het toestel uit de Broadcasting groep te verwijderen, houdt u de



Mode Selection toets nogmaals ingedrukt. De equalizer zal “N” tonen, wat aangeeft dat het toestel niet verbonden is met een ander GPO Manhattan toestel.

Zodra u tevreden bent met de groep, gebruikt u de volgende knoppen om de audioweergave te regelen:

Tik op de toets Play/Pause om het huidige nummer af te spelen of te pauzeren.

Tik op de toets Skip/Next om vooruit te springen naar het volgende nummer op het aangesloten apparaat.

Houd de toets Skip/Next ingedrukt om de koppeling van het huidige apparaat ongedaan te maken en de koppeling opnieuw te starten zoals hierboven beschreven.

Tik op de toets Skip/Back om terug te gaan naar het vorige nummer op het aangesloten apparaat.

De toets Skip/Back ingedrukt houden heeft geen effect.



AUX-modus

Vanuit de Bluetooth-modus tikt u eenmaal op de moduskeuzetoets om de AUX-modus te selecteren. De LED-indicator voor de modusselectie wordt rood.

Om muziek van een apart apparaat af te spelen, sluit u de GPO Manhattan aan met een AUX-kabel. Het afspelen moet worden geregeld vanaf het aangesloten apparaat.

Tikken op de toets Play/Pause in de AUX-modus heeft geen effect.

Het aantikken of ingedrukt houden van de toets Skip/Next in de AUX-modus heeft geen effect.

Het aantikken of ingedrukt houden van de toets Skip/Back in de AUX-modus heeft geen effect.



USB-Modus

Vanuit AUX-modus, tikt u nogmaals op de knop Modusselectie om USB-modus te selecteren. De LED voor modusselectie wordt paars.

Om muziek af te spelen die is opgeslagen op een USB-apparaat in mp3-formaat, steekt u het USB-apparaat in de USB-poort van uw GPO Manhattan. Het afspelen kan dan worden geregeld vanaf de GPO Manhattan.

Tik op de knop Play/Pause om het huidige nummer af te spelen of te pauzeren.

Tik op de toets Skip/Next om vooruit te springen naar het volgende nummer op het USB-apparaat.

Houd de toets Skip/Next ingedrukt om snel vooruit te spoelen door het huidige nummer totdat de toets wordt losgelaten.



Tik op de toets Skip/Back om terug te gaan naar het vorige liedje op het USB-medium.



Houd de Skip/Back toets ingedrukt om terug te spoelen door het huidige liedje totdat de toets wordt losgelaten.



Microfoons gebruiken - Alle modi

Houd de Play/Pause toets ingedrukt om de MIC geluidseffecten in te schakelen.

Tik op de Play/Pause toets om door de zeven soorten geluidseffecten te bladeren:

- Diakritisch
- Magie
- Schreeuwt
- Godin
- Mannelijk
- Baby stem
- Pop galm



Opnemen op een USB-apparaat

Tijdens het afspelen in Bluetooth of AUX modus, plaatst u het USB-apparaat waarop u wilt opnemen.

Tik op de opnametoets om de opname te starten. De indicator gaat aan.

Tik nogmaals op de opnametoets om de opname te stoppen. De indicator gaat uit.

Als de indicator niet aangaat, controleer dan of er voldoende geheugen is op het USB-apparaat.



Opladen van de GPO Manhattan

Uw GPO Manhattan kan tot vier uur muziek afspelen in Bluetooth-modus, afhankelijk van de volume-instelling. Het duurt ongeveer twee uur om volledig op te laden.

Om de GPO Manhattan op te laden, steekt u de oplaadkabel in het toestel en sluit u het aan op een stopcontact.

Tijdens het opladen knippert het blauwe oplaadlampje.

Zodra het toestel volledig is opgeladen, zal het oplaadlampje continu blauw oplichten.

Als de batterij van het apparaat bijna leeg is, knippert het rode aan/uit-lampje langzaam.

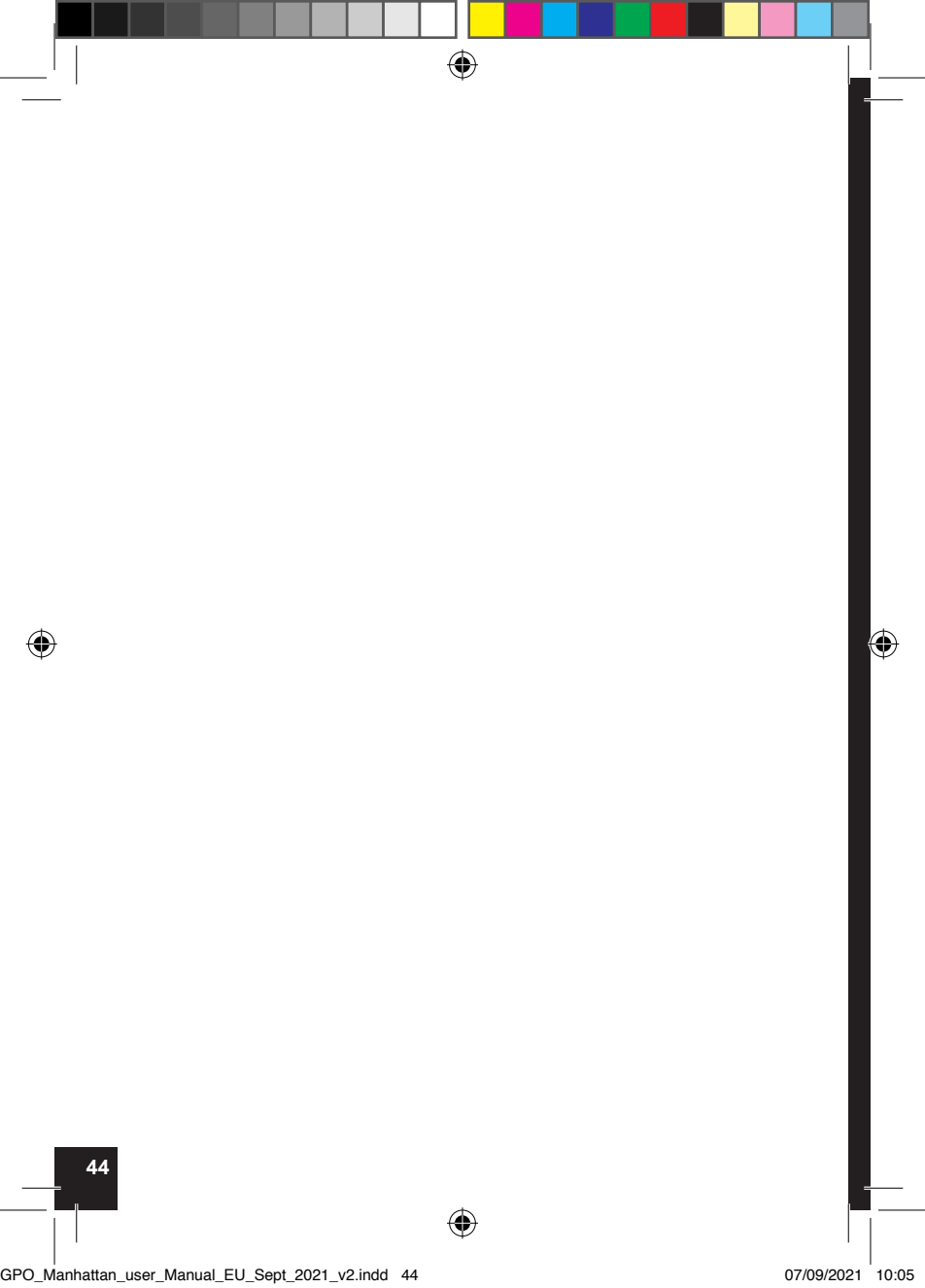



Spanish

Introducción

Gracias por comprar el altavoz GPO Manhattan. Este altavoz compacto y portátil te permite escuchar música a través de Bluetooth, USB o utilizando la entrada AUX.

Incluye:

- 1 altavoz GPO Manhattan
- 1 cable de alimentación
- 1 cable AUX

Antes de utilizar el altavoz GPO Manhattan por primera vez, asegúrese de leer estas instrucciones y conservarlas para futuras consultas.

Ubicaciones de control

- | | |
|-------------------------------|-----------------------------------|
| 1. Pantalla LED | 12. Puerto USB |
| 2. Botón de volumen | 13. Tomas de corriente auxiliares |
| 3. Botón de equilibrio | 14. Mic1 y Mic2 apagados |
| 4. Botón de control de graves | 15. Eco |
| 5. Mando de control de agudos | 16. Altavoces |
| 6. Botón de encendido | 17. Mango |
| 7. Luces | 18. Toma de corriente (trasera) |
| 8. Botón de selección de modo | 19. Speel / pause |
| 9. Emparejamiento | 20. Saltar / Atrás |
| 10. Registro | 21. Saltar / Próxima |
| 11. Tomas de micrófono | |

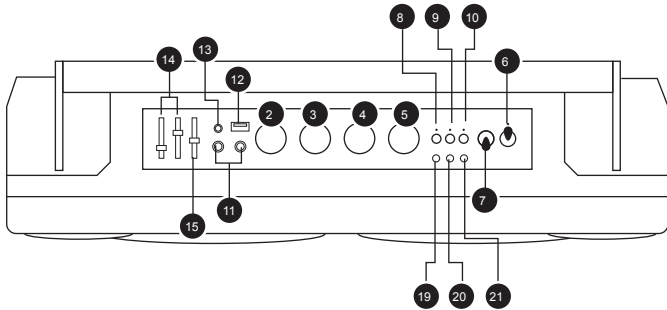
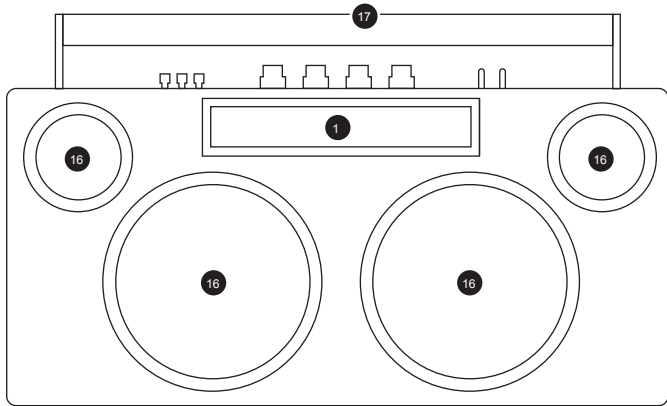



Uso del GPO Manhattan

Utiliza el botón de encendido para encender o apagar tu GPO Manhattan.

Cuando está encendido, el indicador LED del botón de encendido se ilumina.

Control de sonido

Ajusta el volumen, el balance, los graves y los agudos del GPO Manhattan mediante los botones situados en la parte superior de la unidad.



Pantalla LED



Utiliza el interruptor LED de la parte superior de la unidad para encender o apagar la pantalla LED de tu GPO Manhattan.

Cuando se enciende, el indicador LED del botón de encendido se ilumina y la pantalla de la parte frontal de la unidad es visible.

Toque el botón Emparejar para recorrer seis modos de visualización preestablecidos. Si no se reproduce música, la pantalla LED mostrará una muestra del modo de visualización preestablecido, independientemente de la selección de visualización.

Modos de reproducción

El GPO Manhattan tiene tres modos: Bluetooth, AUX y USB.



Modo Bluetooth

El modo Bluetooth se puede seleccionar de dos maneras:

1. Cuando se enciende el GPO Manhattan, se selecciona por defecto el modo Bluetooth y el dispositivo busca emparejarse con un dispositivo cercano.
2. Desde el modo AUX, pulse una vez el botón selector de modo.

El LED de selección de modo se vuelve azul.

Mantenga pulsado el botón Pair para activar la función de emparejamiento. El LED de emparejamiento parpadea rápidamente para indicar que el GPO Manhattan está en modo de emparejamiento.

Utiliza la función de emparejamiento por Bluetooth de tu smartphone u otro dispositivo con Bluetooth para identificar y conectarte a la unidad GPO Manhattan. La reproducción se puede gestionar desde el dispositivo directamente o desde el GPO Manhattan.



Modo de distribución

Esta es una característica específica del GPO Manhattan. Permite enlazar varias unidades y controlarlas como una sola entidad.

Mantenga pulsado el botón selector de modo para activar el modo de emisión. El ecualizador muestra "H", indicando que se trata de la unidad anfitriona de emisión.

Para cada GPO Manhattan adicional, encienda la unidad y mantenga pulsado el botón selector de modo para entrar en el modo de emisión, y vuelva a mantener pulsado el botón selector de modo para designar la unidad como unidad de medios de emisión. El ecualizador mostrará "S".

Para retirar la unidad del grupo de emisión, mantenga pulsado el botón de selección de modo una vez más. El ecualizador mostrará "N",

indicando que la unidad no está conectada a ninguna otra unidad GPO Manhattan.

Una vez que esté satisfecho con el grupo, utilice los siguientes botones para controlar la reproducción de audio:

Toca el botón Play/Pause para reproducir o pausar la canción actual.

Pulsa el botón Skip/Next para saltar a la siguiente canción en el dispositivo conectado.

Mantenga pulsado el botón Skip/Next para cancelar el emparejamiento del dispositivo actual y reiniciar el emparejamiento como se ha descrito anteriormente.

Pulsa el botón Skip/Back para volver a la canción anterior en el dispositivo conectado.

Mantener pulsado el botón Skip/Back no tiene ningún efecto.

Modo AUX

En el modo Bluetooth, pulse el botón selector de modo una vez para seleccionar el modo AUX. El indicador LED del selector de modo se vuelve rojo.

Para reproducir música desde otro dispositivo, conecta el GPO Manhattan con un cable AUX. La reproducción debe ser controlada desde el dispositivo conectado.

Tocar el botón Play/Pause en el modo AUX no tiene ningún efecto.

Tocar o mantener pulsado el botón Skip/Next en el modo AUX no tiene ningún efecto.

Mantener pulsado el botón Skip/Back en el modo AUX no tiene ningún efecto.



Modo USB

En el modo AUX, pulse el botón de selección de modo una vez más para seleccionar el modo USB. El LED de selección de modo se pone de color púrpura.

Para reproducir música guardada en un dispositivo USB en formato MP3, inserta el dispositivo USB en el puerto USB de tu GPO Manhattan. La reproducción se puede gestionar entonces desde el GPO Manhattan.

Pulsa el botón de Play/Pause para reproducir o pausar la canción actual.

Pulsa el botón Skip/Next para pasar a la siguiente canción de la memoria USB.

Mantén pulsado el botón Skip/Next para avanzar rápidamente por la canción actual hasta que sueltes el botón.

Pulsa el botón de Skip/Back para volver a la canción anterior en la memoria USB.

Mantenga pulsado el botón Skip/Back para saltar hacia atrás en la canción actual hasta que suelte el botón.





Utilización de los micrófonos - Todos los modos

Mantén pulsado el botón Play/Pause para activar los efectos de sonido MIC.

Pulse el botón Play/Pause para recorrer los siete tipos de efectos de sonido:

- Diacríticos
- Magia
- Gritos
- Diosa
- Hombre
- La voz del bebé
- Reverberación pop



Grabación en un dispositivo USB

Durante la reproducción en modo Bluetooth o AUX, inserta el dispositivo USB en el que deseas grabar.

Pulsa el botón de grabación para empezar a grabar. El indicador se enciende.

Pulse de nuevo el botón de grabación para detener la grabación. El indicador se apaga.

Si el indicador no se enciende, compruebe que el dispositivo USB tiene suficiente memoria.



Carga del GPO Manhattan



Tu GPO Manhattan puede reproducir música hasta cuatro horas en modo Bluetooth, dependiendo del ajuste de volumen. Tarda aproximadamente dos horas en cargarse por completo.

Para cargar el GPO Manhattan, inserte el cable de carga y conecte el dispositivo a una toma de corriente.

Durante la carga, el indicador de carga azul parpadeará.

Una vez que la unidad esté completamente cargada, la luz de carga permanecerá azul en todo momento.

Cuando la batería del dispositivo está baja, la luz roja de encendido parpadea lentamente.



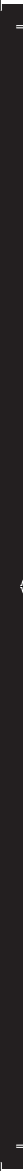
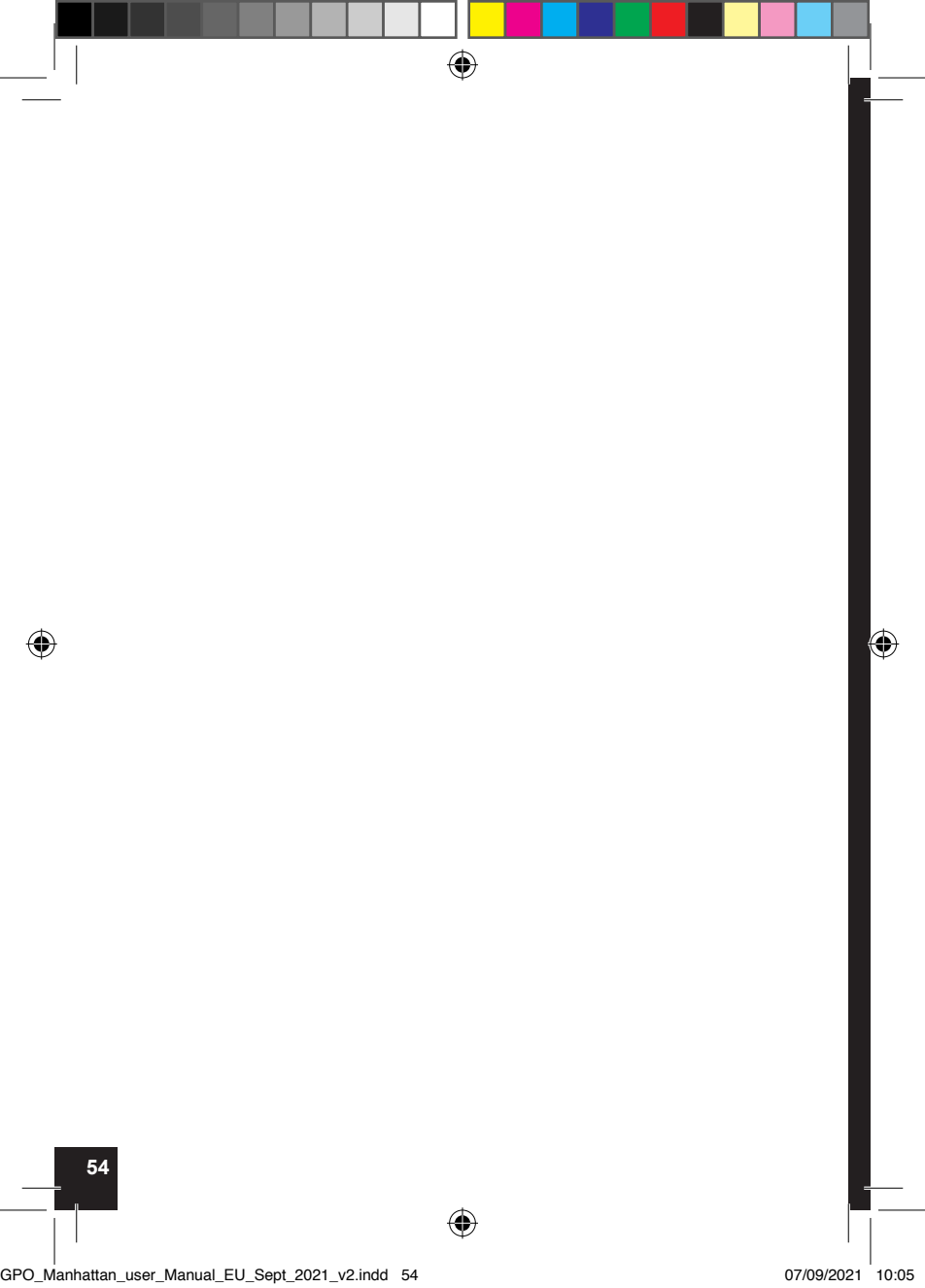



Italian

Introduzione

Grazie per aver acquistato il diffusore GPO Manhattan. Questo altoparlante compatto e portatile permette di ascoltare la musica via Bluetooth, USB o utilizzando l'ingresso AUX.

Comprende:

- 1 altoparlante GPO Manhattan
- 1x cavo di alimentazione
- 1x cavo AUX

Prima di usare il suo diffusore GPO Manhattan per la prima volta, si assicuri di leggere queste istruzioni e le conservi per riferimento futuro.

Posizioni di controllo

- | | |
|-----------------------------------------|------------------------------------|
| 1. Display a LED | 12. Porta USB |
| 2. Pulsante del volume | 13. Prese di corrente ausiliarie |
| 3. Pulsante di bilanciamento | 14. Mic1 e Mic2 spenti |
| 4. Pulsante di controllo dei bassi | 15. Echo |
| 5. Manopola di controllo degli alti | 16. Altoparlanti |
| 6. Pulsante di accensione | 17. Maniglia |
| 7. Luci | 18. Presa di corrente (posteriore) |
| 8. Pulsante di selezione della modalità | 19. Play/Pausa |
| 9. Abbinamento | 20. Salta/Indietro |
| 10. Registra | 21. Salta/Avanti |
| 11. Prese per il microfono | |

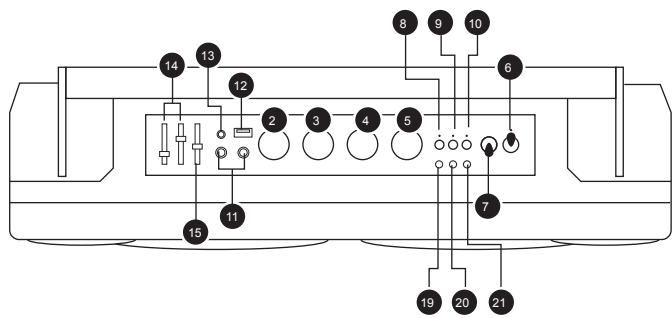
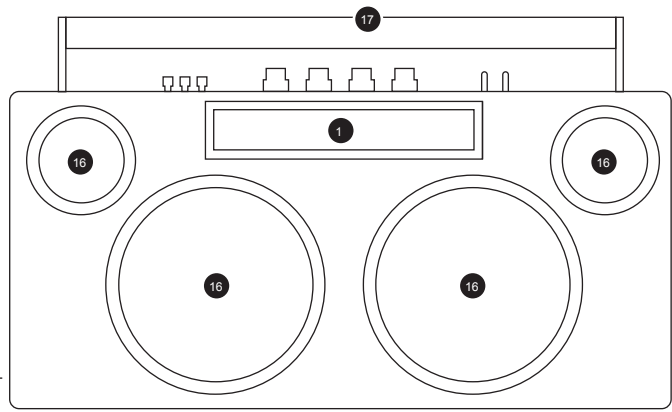



Utilizzo del GPO Manhattan

Usate il pulsante di accensione per accendere o spegnere il vostro GPO Manhattan

Quando è acceso, l'indicatore LED del pulsante di accensione si accende.

Controllo del suono

Regola il volume, il bilanciamento, i bassi e gli alti del GPO Manhattan usando i pulsanti sulla parte superiore dell'unità.

Display a LED



Usate l'interruttore a LED sulla parte superiore dell'unità per accendere o spegnere il display a LED del vostro GPO Manhattan.

Quando è acceso, l'indicatore LED sul pulsante di accensione si accende e il display sulla parte anteriore dell'unità è visibile.

Toccare il pulsante Associa per scorrere le sei modalità di visualizzazione preimpostate. Se non viene riprodotta alcuna musica, il display a LED visualizzerà un campione della modalità di visualizzazione preimpostata, indipendentemente dalla selezione del display.



Modalità di riproduzione

Il GPO Manhattan ha tre modalità: Bluetooth, AUX e USB.

Modalità Bluetooth

La modalità Bluetooth può essere selezionata in due modi:

1. Quando il GPO Manhattan è acceso, la modalità Bluetooth è selezionata di default e l'unità cercherà di accoppiarsi con un dispositivo vicino.
2. Dalla modalità AUX, premere una volta il pulsante di selezione della modalità.

Il LED di selezione della modalità diventa blu.

Tenere premuto il pulsante Pair per attivare la funzione di accoppiamento. Il LED di accoppiamento lampeggia rapidamente per indicare che il GPO Manhattan è in modalità di accoppiamento.



Usa la funzione di accoppiamento Bluetooth del tuo smartphone o altro dispositivo abilitato Bluetooth per identificare e connettersi all'unità GPO Manhattan. La riproduzione può quindi essere gestita direttamente dal dispositivo o dal GPO Manhattan.

Modo di distribuzione

Questa è una caratteristica specifica del GPO Manhattan. Permette a più unità di essere collegate insieme e controllate come una singola entità.

Tenere premuto il pulsante del selettore di modalità per attivare la modalità di trasmissione. L'equalizzatore visualizza "H", indicando che questa è l'unità host di trasmissione.

Per ogni GPO Manhattan aggiuntivo, accendete l'unità e tenete premuto il pulsante di selezione della modalità per entrare in modalità di trasmissione, quindi tenete nuovamente premuto il pulsante di selezione della modalità per designare l'unità come unità di trasmissione. L'equalizzatore visualizzerà "S".



Per rimuovere l'unità dal gruppo di trasmissione, tenere premuto ancora una volta il pulsante di selezione della modalità. L'equalizzatore mostrerà "N", indicando che l'unità non è collegata ad altre unità GPO Manhattan.

Una volta che siete soddisfatti della banda, usate i seguenti pulsanti per controllare la riproduzione audio:

Tocca il pulsante Play/Pause per riprodurre o mettere in pausa il brano corrente.

Premi il pulsante Skip/Next per passare al brano successivo sul dispositivo collegato.

Premere e tenere premuto il pulsante Skip/Next per annullare l'accoppiamento del dispositivo corrente e riavviare l'accoppiamento come descritto sopra.

Premi il pulsante Skip/Back per tornare al brano precedente sul dispositivo collegato.

Tenere premuto il pulsante Skip/Back non ha alcun effetto.



Modalità AUX

In modalità Bluetooth, premere una volta il pulsante del selettore di modalità per selezionare la modalità AUX. L'indicatore LED del selettore di modalità diventa rosso.

Per riprodurre la musica da un altro dispositivo, collega il GPO Manhattan con un cavo AUX. La riproduzione deve essere controllata dal dispositivo collegato.

Toccare il pulsante Play/Pause in modalità AUX non ha alcun effetto.

Toccare o tenere premuto il pulsante Skip/Next in modalità AUX non ha alcun effetto.

Premere o tenere premuto il pulsante Skip/Back in modalità AUX non ha alcun effetto.



Modalità USB

In modalità AUX, premere ancora una volta il pulsante di selezione della modalità per selezionare la modalità USB. Il LED di selezione della modalità diventa viola.

Per riprodurre la musica salvata su un dispositivo USB in formato MP3, inserisci il dispositivo USB nella porta USB del tuo GPO Manhattan. La riproduzione può quindi essere gestita dal GPO Manhattan.

Premi il pulsante Play/Pause per riprodurre o mettere in pausa il brano corrente.

Premi il pulsante Skip/Next per passare al brano successivo sulla chiavetta USB.

Tenere premuto il pulsante Skip/Next per avanzare velocemente attraverso il brano corrente fino a quando non si rilascia il pulsante.

Premi il pulsante Skip/Back per tornare al brano precedente sulla chiavetta USB.

Tieni premuto il pulsante Skip/Back per saltare all'indietro nel brano corrente finché non lo rilasci.



Uso dei microfoni - Tutte le modalità

Tenete premuto il pulsante Play/Pause per attivare gli effetti sonori MIC.

Premete il pulsante Play/Pause per scorrere i sette tipi di effetti sonori:

- Diacritici
- Magia
- Urla
- Dea
- Uomo
- La voce del bambino
- Riverbero pop



Registrazione su un dispositivo USB



Durante la riproduzione in modalità Bluetooth o AUX, inserite il dispositivo USB su cui volete registrare.

Premete il pulsante di registrazione per avviare la registrazione. L'indicatore si accende.

Premete di nuovo il pulsante di registrazione per interrompere la registrazione. L'indicatore si spegne.

Se l'indicatore non si accende, controllate che il dispositivo USB abbia abbastanza memoria.



Caricamento del GPO Manhattan



Il tuo GPO Manhattan può riprodurre musica fino a quattro ore in modalità Bluetooth, a seconda dell'impostazione del volume. Ci vogliono circa due ore per caricarlo completamente.

Per caricare il GPO Manhattan, inserite il cavo di ricarica e inserite il dispositivo in una presa elettrica.

Durante la ricarica, l'indicatore di carica blu lampeggia.

Una volta che l'unità è completamente carica, la luce di carica rimarrà blu in ogni momento.

Quando la batteria del dispositivo è scarica, la spia rossa dell'alimentazione lampeggia lentamente.



EN

Hereby ProtelX, declares that this equipment (**GPO MANHATTAN**) is in compliance with the essential requirements and other relevant provisions of Directive, you can access a copy of this certificate on www.gporetro.com/Certificate-of-Conformity

DE

Hiermit erklärt ProtelX, dass dieses Gerät (**GPO MANHATTAN**) den grundlegenden Anforderungen und anderen relevanten Bestimmungen der Richtlinie entspricht, Sie können eine Kopie dieses Zertifikats runterladen www.gporetro.com/Certificate-of-Conformity

FR

Par ProtelX, déclare que cet équipement (**GPO MANHATTAN**) est conforme aux exigences essentielles et aux autres dispositions pertinentes de la Directive, vous pouvez accéder à une copie de ce certificat sur www.gporetro.com/Certificate-of-Conformity

NL

Hierbij verklaart ProtelX dat dit apparaat (**GPO MANHATTAN**) voldoet aan de essentiële eisen en andere relevante bepalingen van de richtlijn, u kunt een exemplaar van dit certificaat downloaden op www.gporetro.com/Certificate-of-Conformity

ES

ProtelX, declara que este equipo (**GPO MANHATTAN**) cumple con los esenciales y otras disposiciones pertinentes de la Directiva, puede acceder a una copia de este certificado en www.gporetro.com/Certificate-of-Conformity

IT

Con la presente, ProtelX dichiara che questo dispositivo (**GPO MANHATTAN**) è conforme ai requisiti essenziali e alle altre disposizioni pertinenti della direttiva, è possibile scaricare una copia di questo certificato su www.gporetro.com/Certificate-of-Conformity



www.gporetro.com

IMPORTED AND DISTRIBUTED BY:

ProTelX Ltd, Unit 6, Park 17 Industrial Estate, Moss Lane, Whitefield, Manchester, M45 8FJ UK

EU REPRESENTATIVE:

CET Product Service Ltd, Osterholzallee 144, 71636 Ludwigsburg, Germany